

OTPE1(NF/GR)

v.7

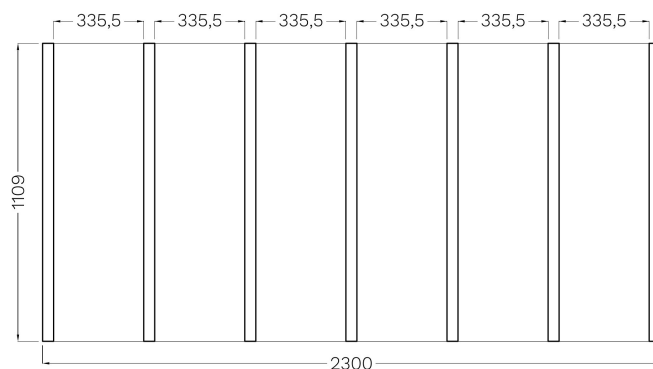
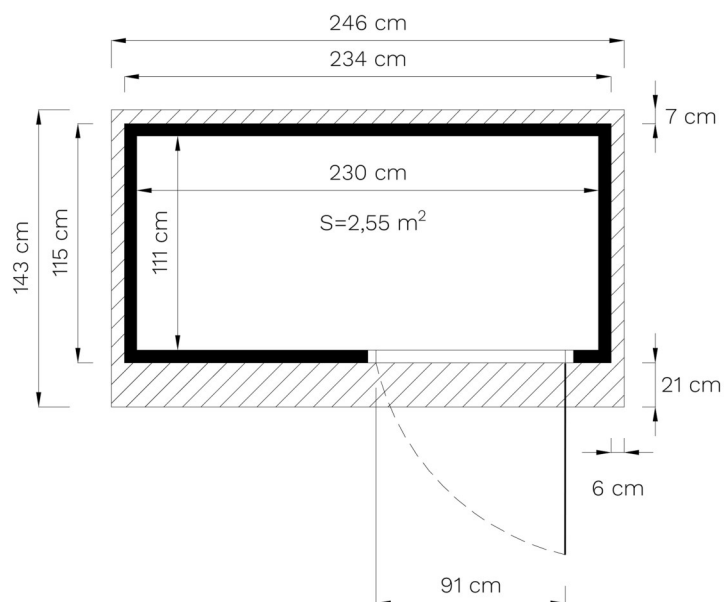
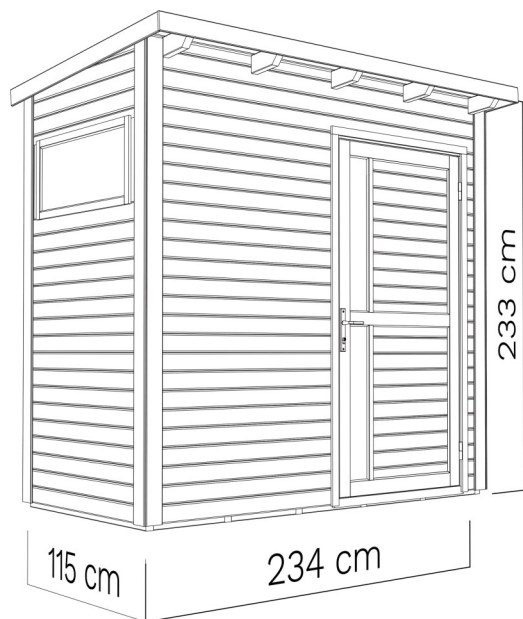

DE - Technische Änderungen vorbehalten.

Alle Maße sind ca. Maße.

EN - Technical modifications reserved.

All dimensions are approximate dimensions.



OTPE1(NF/GR)

DE **Bevor Sie beginnen**

• Es ist empfehlenswert sich etwas Zeit zu nehmen, um die Aufbauanleitung anzusehen, bevor mit dem Aufbau begonnen wird. • Alle Schritte für den Aufbau werden – auch in Detailbildern – dargestellt. • Die vorgegebene Reihenfolge ist zu beachten. • Bitte prüfen Sie vor dem Aufbau anhand der Teileliste die Vollständigkeit und den Zustand der Lieferung. • Besonders wichtig ist der Holzschutz! Die Boden-elemente sind vor dem Aufbau von unten mit einem geeigneten Holzschutz zu behandeln! • Das für die meisten Produkte online verfügbare Datenblatt bietet weitere wichtige Hinweise für den Aufbau. • Beigefügt sind auch die Garantiebedingungen.

FR **Avant de commencer**

• il est recommandé de prendre le temps de lire les instructions de montage avant de commencer. • Toutes les étapes du montage sont présentées, y compris sur des illustrations détaillées. • L'ordre prescrit doit être respecté. • Avant le montage, vérifiez l'exhaustivité et l'état de la livraison à l'aide de la liste des pièces. • La protection du bois est particulièrement importante! Avant le montage, les éléments de plancher doivent être traités par le bas avec un produit de protection du bois approprié! • La fiche technique disponible en ligne pour la plupart des produits fournit d'autres informations importantes pour le montage. • Les conditions de garantie y sont également jointes.

CZ **Než začnete**

• Doporučujeme, abyste si vzali trochu času k prohlédnutí montážního návodu, než s montáží začnete. • Všechny montážní kroky jsou zobrazeny - také na podrobných obrázcích. • Je nutné dodržovat uvedený postup. • Před montáží zkontrolujte podle seznamu dílů, zda jste obdrželi všechny díly a zda je dodávka v dobrém stavu. • Obzvláště důležitá je dřevěná botka! Podlahové prvky musí být před montáží zespoda ošetřeny vhodným ochranným přípravkem na dřevo! • Datový list, který je k dispozici online pro většinu produktů, poskytuje další důležité pokyny k montáži. • V příloze naleznete také záruční podmínky.

DK **Før du starter**

• Det kan anbefales at tage sig tid til at kigge på samlevejledningen, før du starter samlingen. • Alle trin i samlingen bliver vist – også i detaljerede billeder. • Overhold den angivne rækkefølge. • Kontrollér, at leveringen er fuldstændig og i den rette tilstand ved hjælp af delelisten, før du starter samlingen. • Særligt vigtig er træbeskyttelsen! Gulvelementerne skal behandles med egnede træbeskyttelse nedefra, før du starter samlingen! • Til de fleste produkter kan du finde datablade online, der indeholder yderligere vigtige informationer til samlingen. • Garantibetingelserne er også vedlagt.

NL **Voordat u begint**

• Het is aan te bevelen om de tijd te nemen om de opbouwhandleiding door te nemen voordat er met het opbouwen wordt begonnen. • Alle stappen voor het opbouwen worden - ook met gedetailleerde afbeeldingen - weergegeven. • Neem de aangegeven volgorde in acht. • Controleer voor het opbouwen aan de hand van de onderdelenlijst de volledigheid en de hoedanigheid van de levering. • Bijzonder belangrijk is de bescherming van het hout! De vloerelementen moeten voor het opbouwen van onderen met een geschikt houtbeschermingsmiddel worden behandeld! • Het voor de meeste producten online beschikbare gegevensblad bevat verdere belangrijke aanwijzingen voor de opbouw. • Bijgevoegd zijn ook de

PL **Przed rozpoczęciem**

• Wskazane jest, aby przed przystąpieniem do montażu zapoznać się z instrukcją montażu. • Pokazane są wszystkie etapy montażu – również na szczegółowych zdjęciach. • Należy przestrzegać podanej kolejności. • Przed montażem należy skorzystać z listy części, aby sprawdzić, czy dostawa jest kompletna i w dobrym stanie. • Ochrona drewna jest szczególnie ważna! Przed montażem elementy podłogowe należy zabezpieczyć od dołu odpowiednim środkiem do konserwacji drewna! • Arkusz danych, który jest dostępny online dla większości produktów, zawiera dalsze ważne informacje dotyczące montażu. • Załączone są również warunki gwarancji.

SV **Innan du börjar**

• Vi rekommenderar att du åsidosätter lite tid för att titta igenom monteringsanvisningen innan du påbörjar monteringen. • Alla monteringsstegen visas – även med detaljerade bilder. • Den angivna ordningen måste följas. • Kontrollera att leveransen är komplett och i gott skick innan monteringen påbörjas med hjälp av listan över delar. • Träskyddet är av yttersta vikt! Golvelementen ska behandlas underifrån med lämpligt träskyddsmedel före monteringen! • Annan viktig information före montering finns i databladet (tillgängligt online för de flesta produkter). • Garantivillkoren bifogas också.

RO **Înainte să începeți**

• Vă recomandăm să dedicați puțin timp pentru a consulta Instrucțiunile de asamblare înainte de a începe asamblarea. • Toate etapele de asamblare sunt prezentate amănunțit - și în forma unor figuri detaliate. • Respectați ordinea specificată. • Înainte de asamblare, vă rugăm să verificați lista de componente pentru a vă asigura că furnitura este completă și în stare bună. • Acordați o deosebită atenție protecției lemnului! Elementele de podea trebuie tratate de dedesubt cu o substanță conservantă adecvată pentru protecția lemnului înainte de asamblare! • Fișa de date, care este disponibilă și online pentru majoritatea produselor, oferă informații suplimentare importante cu privire la asamblare. • Atașat veți găsi și condițiile de garanție.











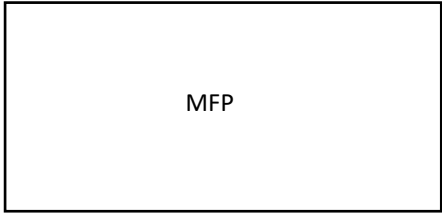
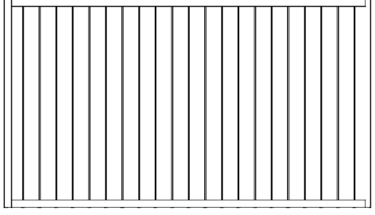
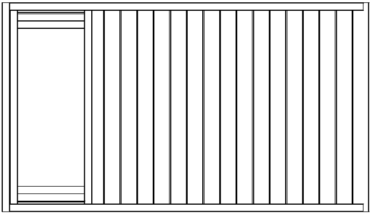
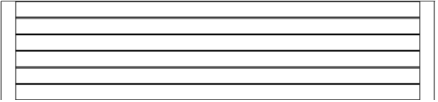
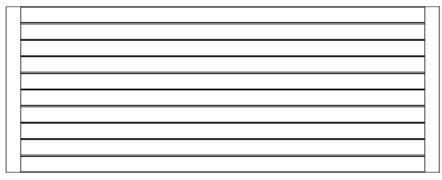
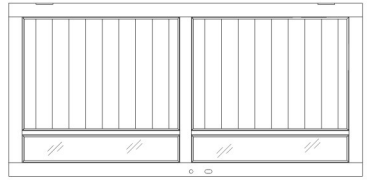
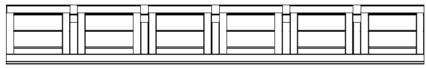

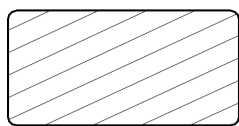

EE **Soovitused enne paigalduse alustamist**

• Soovitame enne paigalduse alustamist võtta aega ja tutvuda paigaldusjuhendiga. • Kõik kokkupaneku etapid on näidatud ka üksikasjalikel piltidel. • Paigaldustööd tuleks teha etteantud järjekorras. • Enne paigalduse alustamist kontrollige detailide nimekirja alusel, kas kõik elemendid on olemas ja ega need pole kahjustada saanud. • Puidukaitse on eriti oluline! Põrandaelemente tuleb enne kokkupanekut töödelda altpoolt sobiva puidukaitsevahendiga! • Andmeleht, mis on enamiku toodete kohta internetis saadaval, pakub kokkupanekuks täiendavat olulist teavet. • Lisatud on ka garantiitingimused.



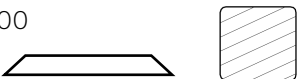



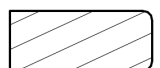
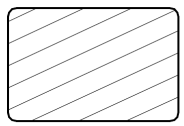
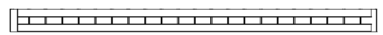



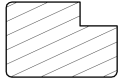
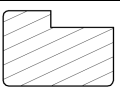

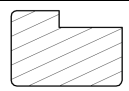
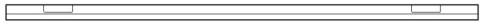





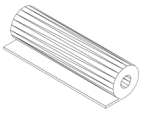

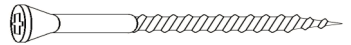

EN **Before assembly**

• We recommend that time is taken to read the assembly instructions prior to assembly. • All assembly steps are shown – also in detailed images. • The step-by-step instructions must be followed. • Before assembly, please use the parts list to check that all components are accounted for and in good condition. • Wood protection is particularly important! The floor elements must be treated from below with a suitable wood preservative before assembly! • The data sheet, which is available online for most products, offers further important information for assembly. • The guarantee conditions are also attached.

OTPE1(NF/GR)

ID	Details in mm (Tolerance/Toleranz ...+ 2mm)	Pcs.	ID	Details in mm (Tolerance/Toleranz ...+ 2mm)	Pcs.
1112	16 x 1109 x 2300 	x 1	148	60 x 1109 x 1953 	x 3
151	60 x 1109 x 1953 	x 1	169	38 x 528 x 1220 	x 2
166	38 x 880 x 1220 	x 2	35	32 x 920 x 1868 	x 1
163	60 x 312 x 2218 	x 1	153	60 x 224 x 2218 	x 1
167	60 x 314 x 1109 	x 1	168	60 x 314 x 1109 	x 1
38	32 x 413 x 896 	x 1	555	3 x 350 x 830 Glass 	x 1
884	40 x 80 x 1105 	x 5	559	5 x 150 x 835 Plexiglass 	x 2
670	12 x 90 x 2245 	x 11	557	12 x 42 x 1040 	x 1
857	40 (41) x 60 (41) x 500 	x 6	595	12 x 42 x 1926 	x 2
1115	41 x 41 x 1109 	x 7	652	12 x 90 x 1410 	x 2
644	12 x 90 x 1237 	x 2	756	19 x 45 x 2245 	x 4
			870	40 x 60 x 1918 	x 2
			150	60 x 120 x 1953 	x 1

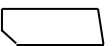
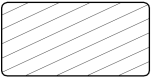
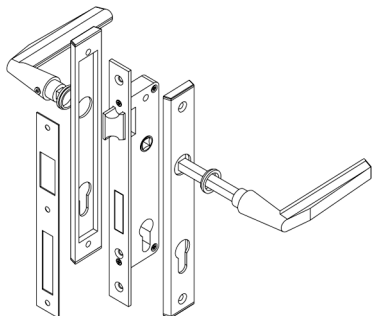
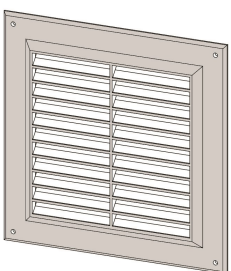
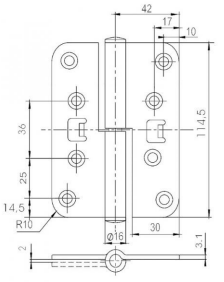
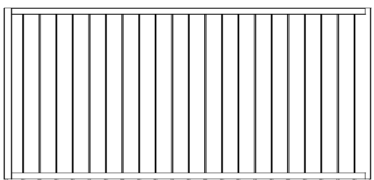
OTPE1(NF/GR)

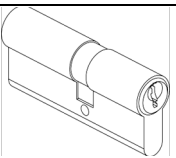
ID	Details in mm (Tolerance/Toleranz ...→ 2mm)	Pcs.	ID	Details in mm (Tolerance/Toleranz ...→ 2mm)	Pcs.
732	19 x 45 x 989 	x 1	860	40 x 60 x 989 	x 1
944	40 x 60 x 1878  	x 1	867	40 x 60 x 989  	x 1
707	15 x 15 x 909 	x 1	1001	15 x 15 x 837 	x 2
946	15 x 15 x 154 	x 4	945	15 x 15 x 807 	x 4
1002	15 x 15 x 324 	x 2	540	3 x 1000 x 2600  NB! Roofing felt for initial covering!	x 1
1129	15 x 15 x 154 	x 4			
1131	15 x 15 x 355 	x 2			
1135	15 x 15 x 838 	x 6			
526	3 X 500 X 2600 NB! Roofing felt for initial covering! 	x 1	1501	Ø4,5 x 90 	x 10
1502	Ø4,5 x 75 	x115	1505	Ø4,5 x 50 	x 107
1506	Ø3,5 x 35 	x 96	1508	Ø4 x 25 	x 4
1510	Ø13 x 19 	x 8	1512	Ø1,5 x 25 	x 40
1514	Ø3 x 14 	x105	874	40 x 80 x 200  	x 5
1531		x 1	1557	VR1515 Ventilation rest 	x 2
1527	Righthand hinge 	x 2	149	60 x 554 x 1953 	x 2
751	19 x 45 x 1930 	x 2	1554	ES60 (30/30) 	x 1

NB! Empfohlen bei Aufbau auf besonders feuchtem Untergrund.
Recommended for assembly on moist ground.

*** Nicht im Lieferumfang enthalten / Not included!**

* Unterlagspad /
* Patio Pads

Min. 9,2 lfm/rm

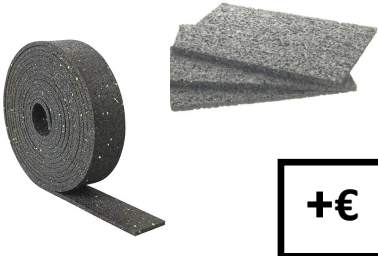

+€

* Imprägniert Kantholz /
* Impregnated beam

40*60*2300 mm

4 Stck/Pcs

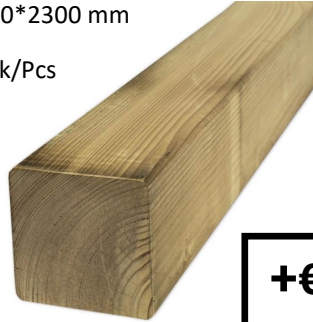

+€

* Schraube /
* Screw

4,5*80 mm

28 Stck/Pcs



+€

Fundamentplan / Foundation Plan

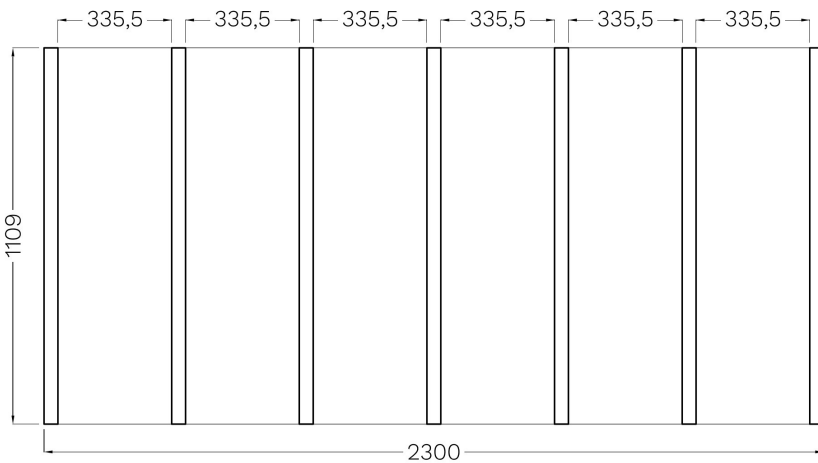

Imprägniertes Kantholz /
Impregnated beam

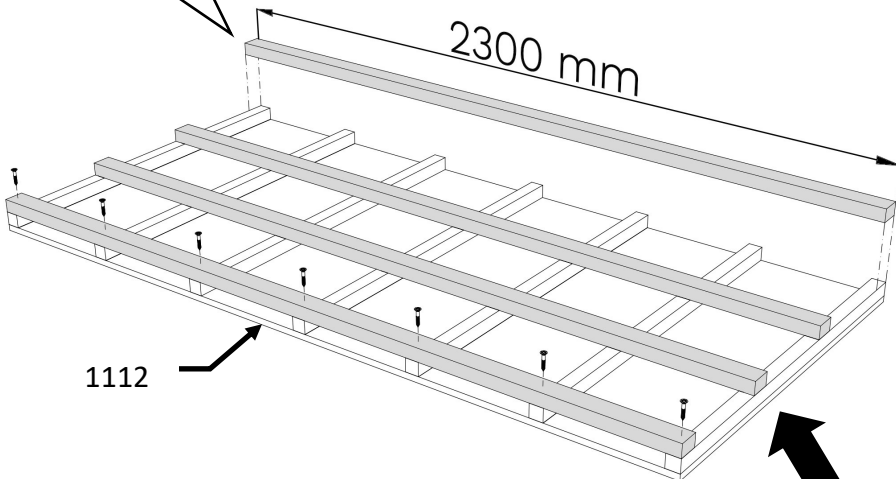

1112

Holzschutzmittel / Wood preservative

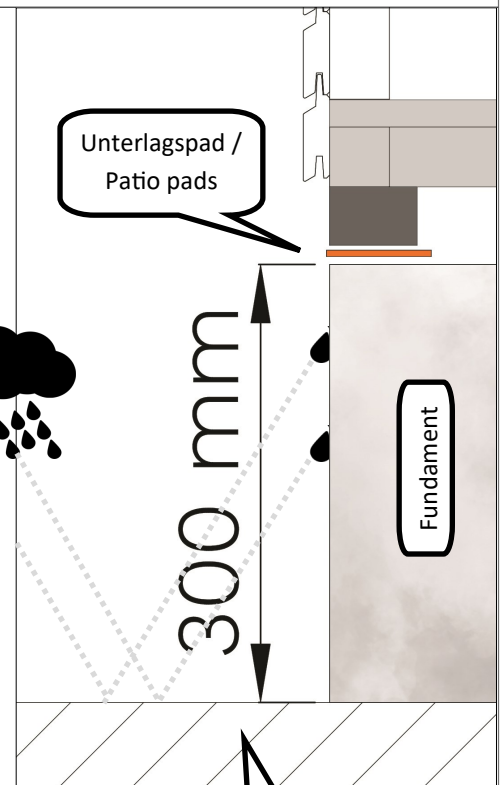

Unterlagspad /
Patio pads

300 mm

Fundament

Der Grund /
Ground

Bitte beachten!

Lass Dein Bauvorhaben vorab bei Deiner zuständigen Gemeinde prüfen, denn die Bauordnungen sowie die Bebauungspläne müssen eingehalten werden.

Please note!

Have your construction project checked in advance at your responsible municipality, because the building regulations and the development plans must be observed.

OTPE1(NF/GR)

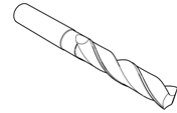
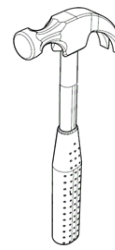
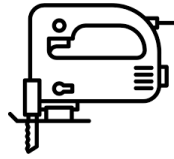
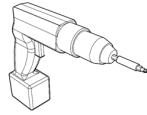

Ø 4 mm
Ø 8 mm

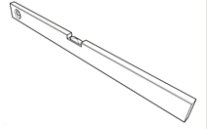
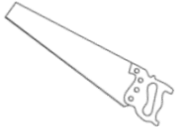
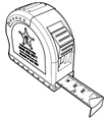

1.

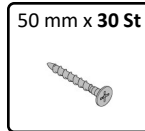

2.

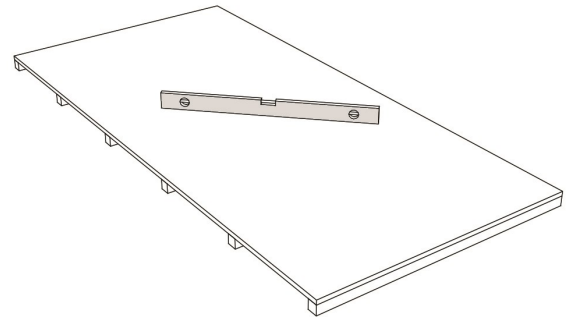
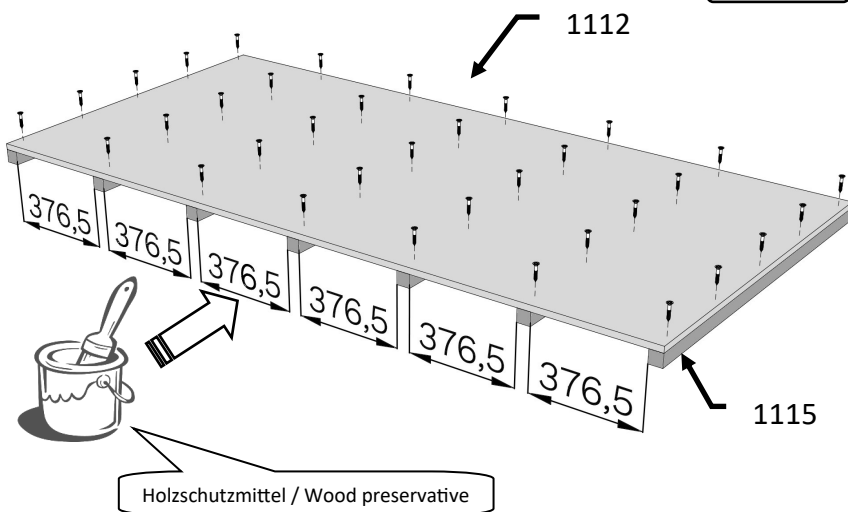

3.

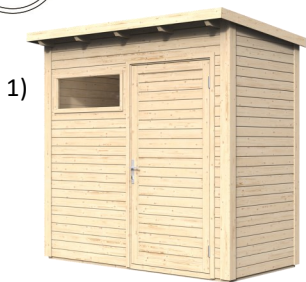

Bertilo Flex Panel System



OTPE1(NF/GR)

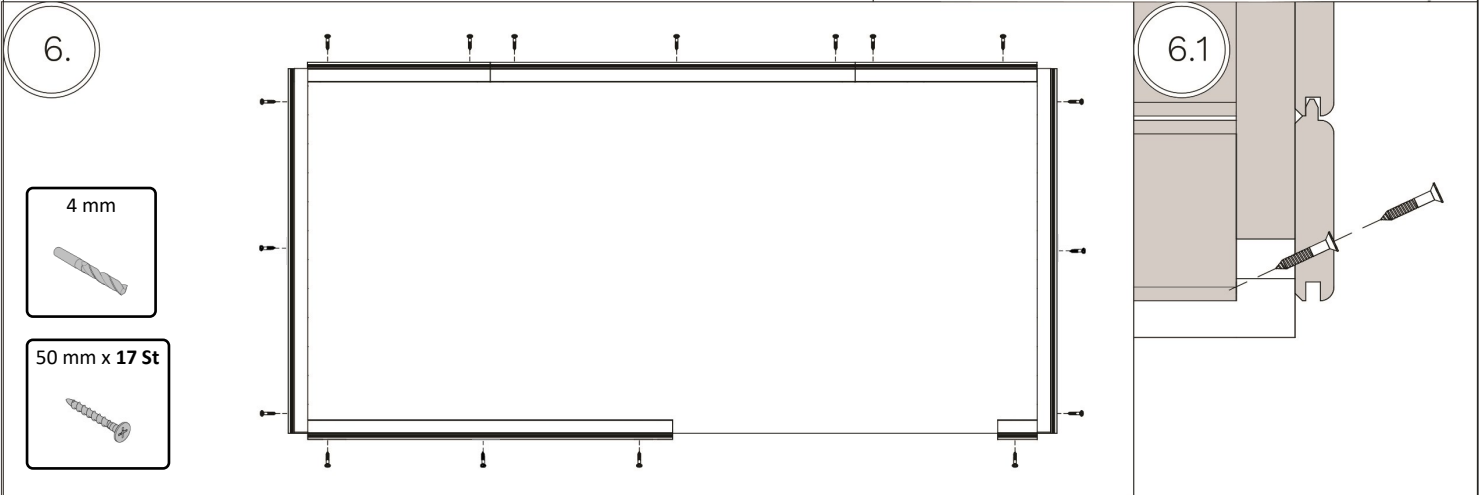
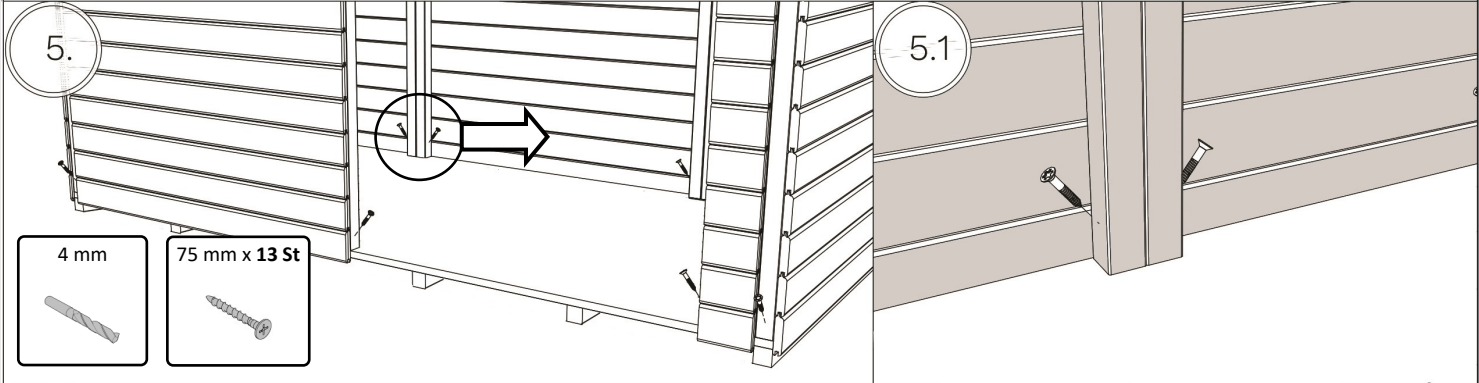
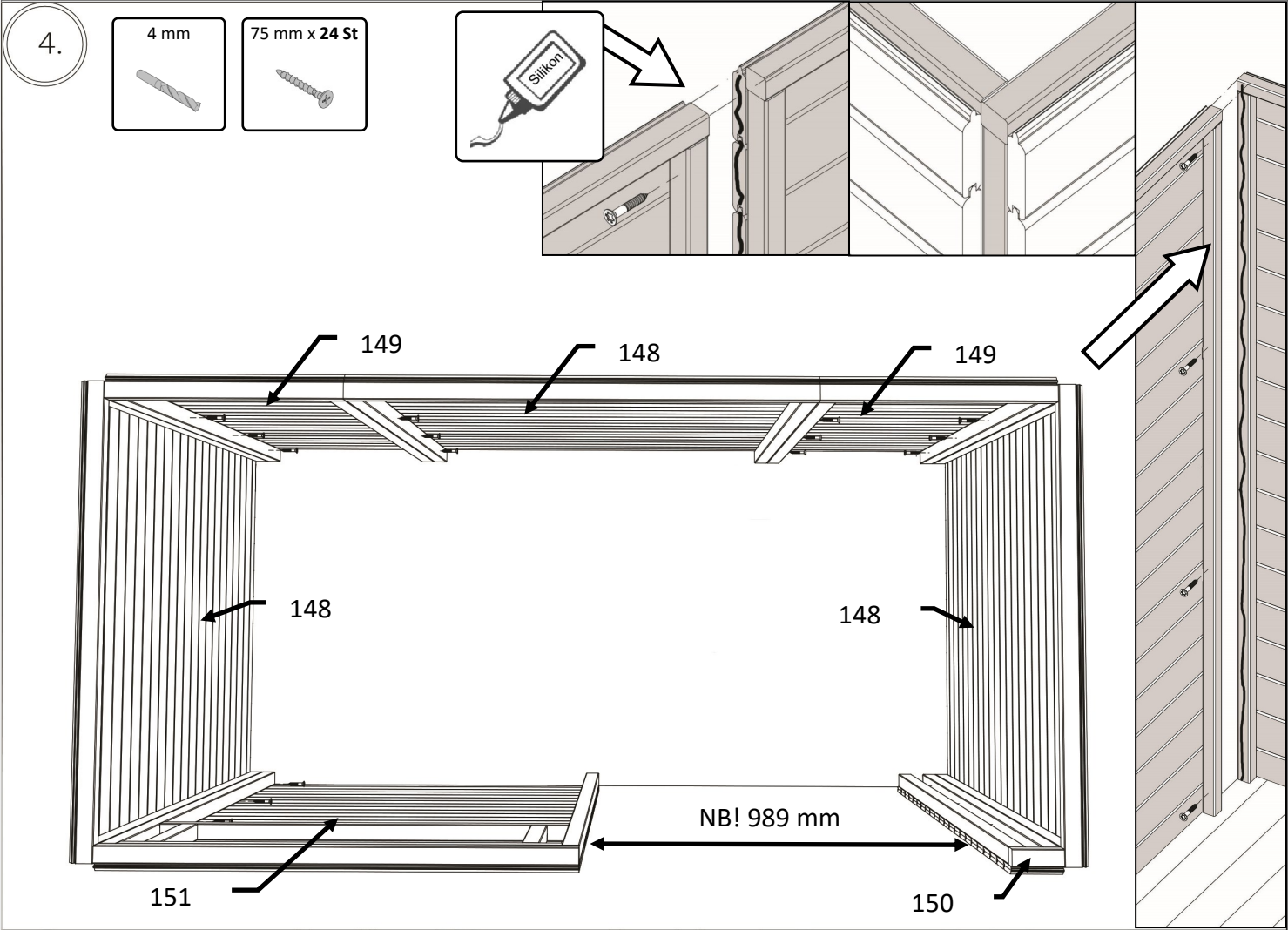

OTPE1(NF/GR)

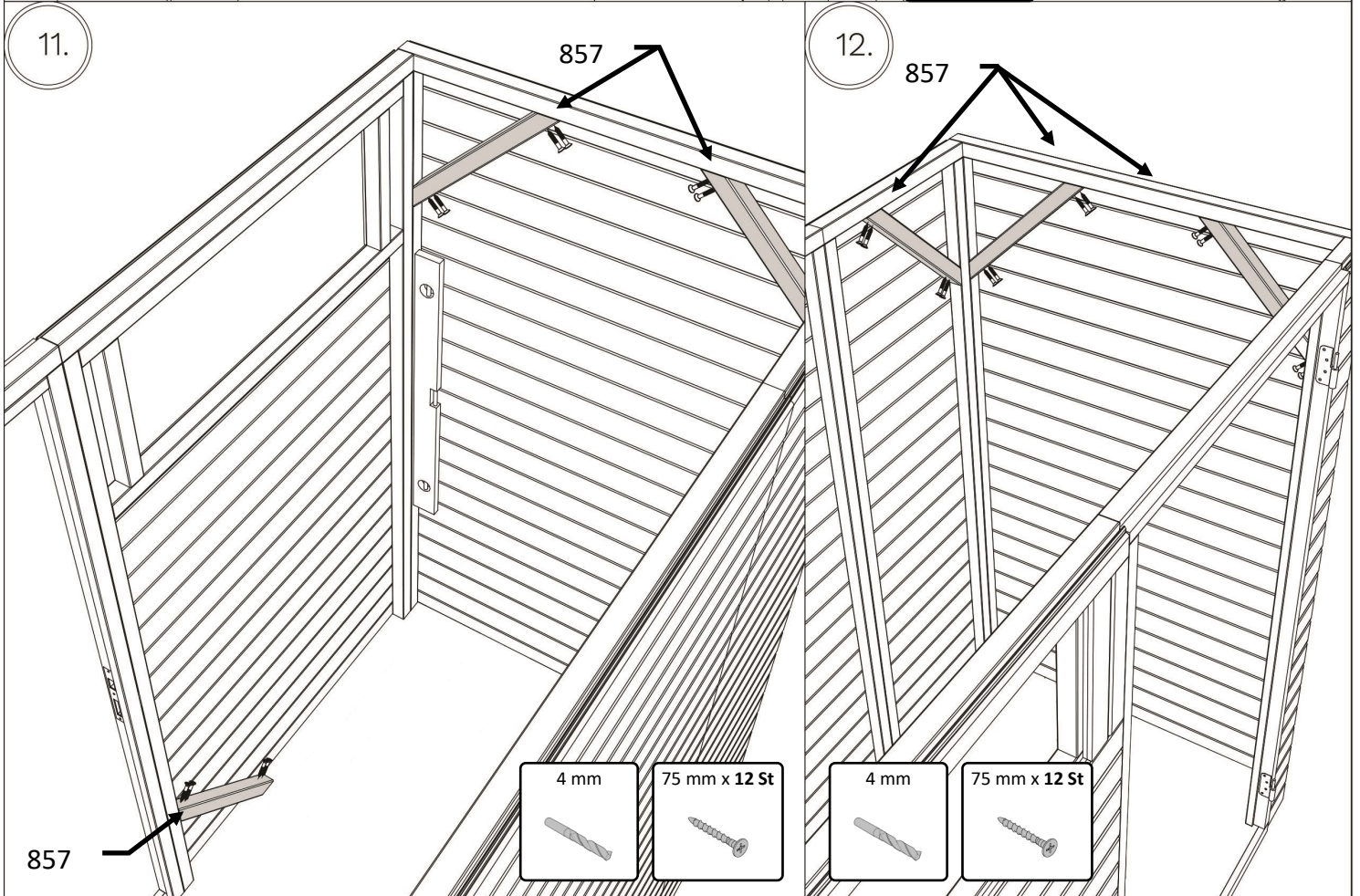
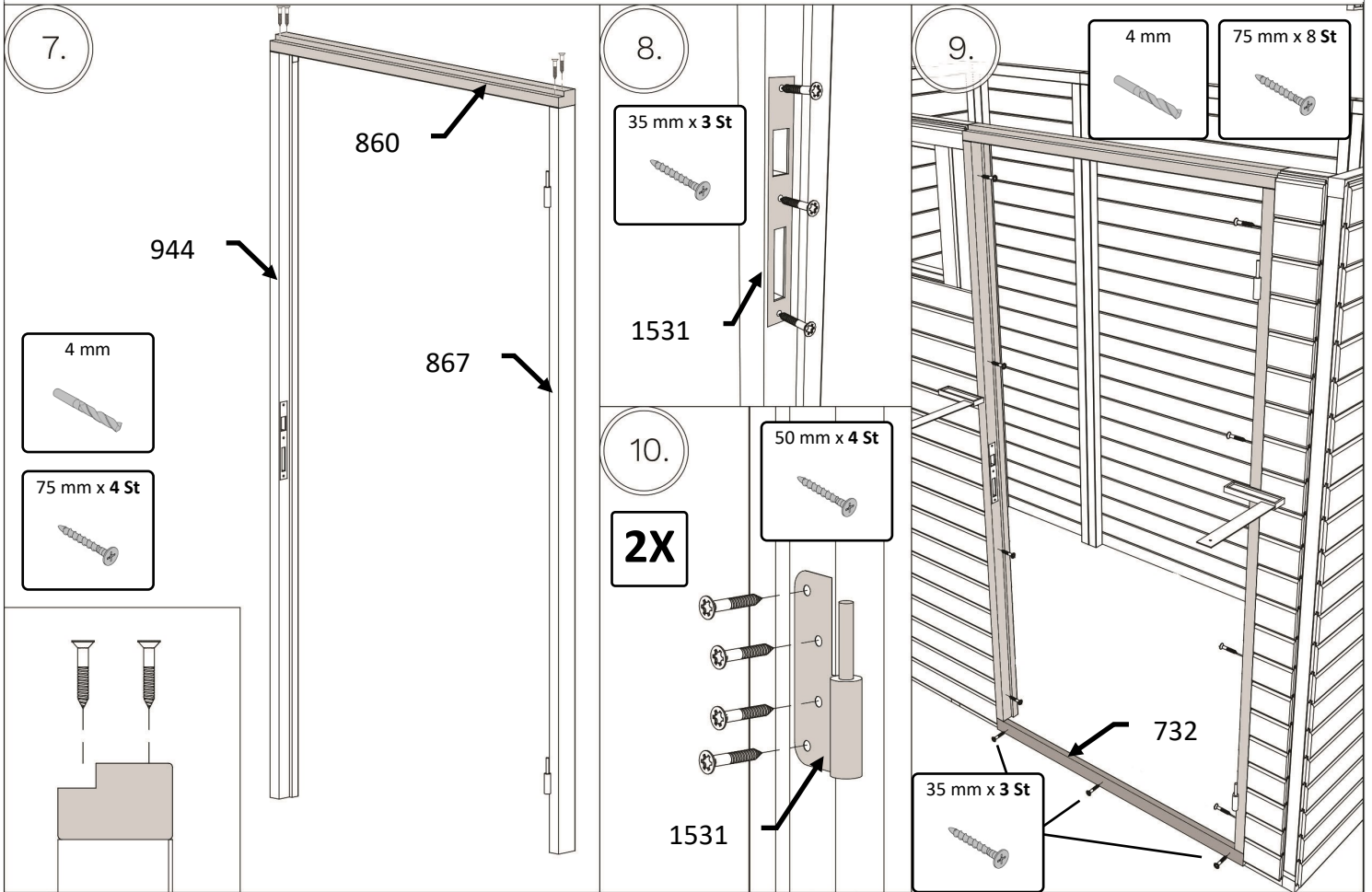

OTPE1(NF/GR)

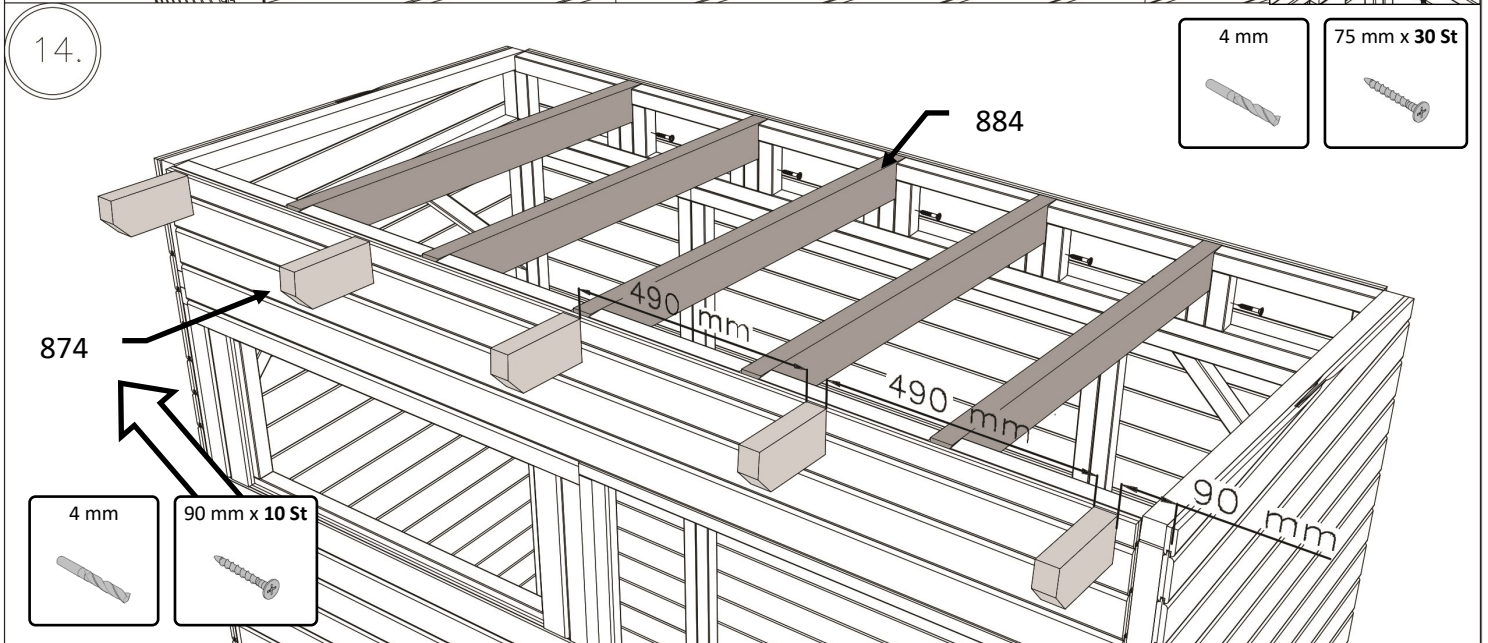
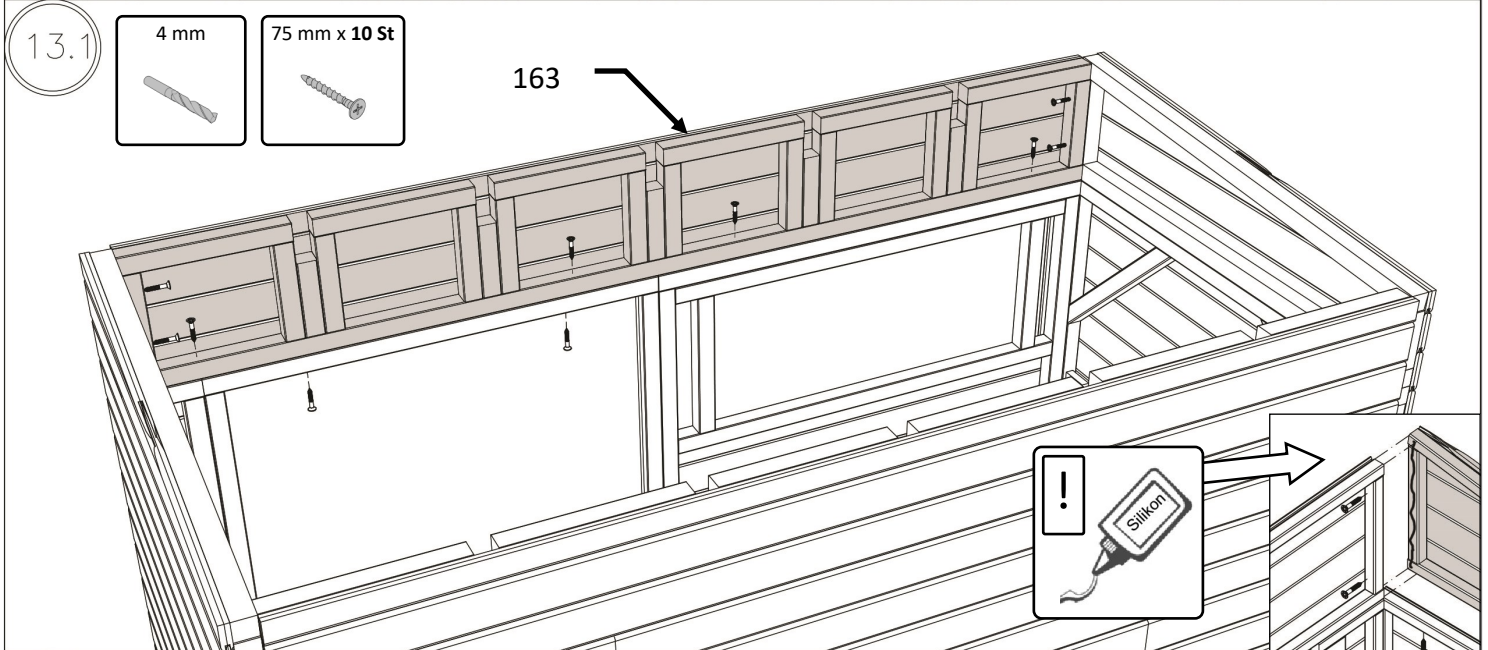
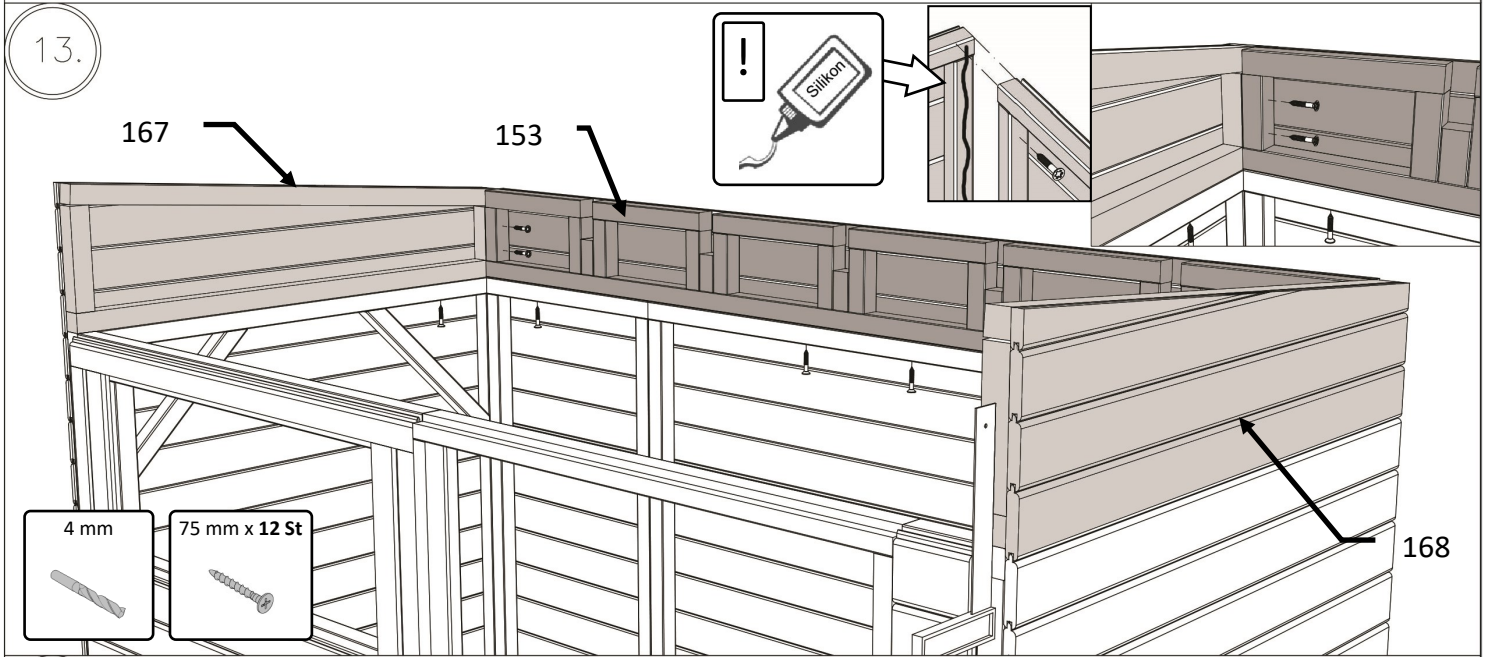

OTPE1(NF/GR)

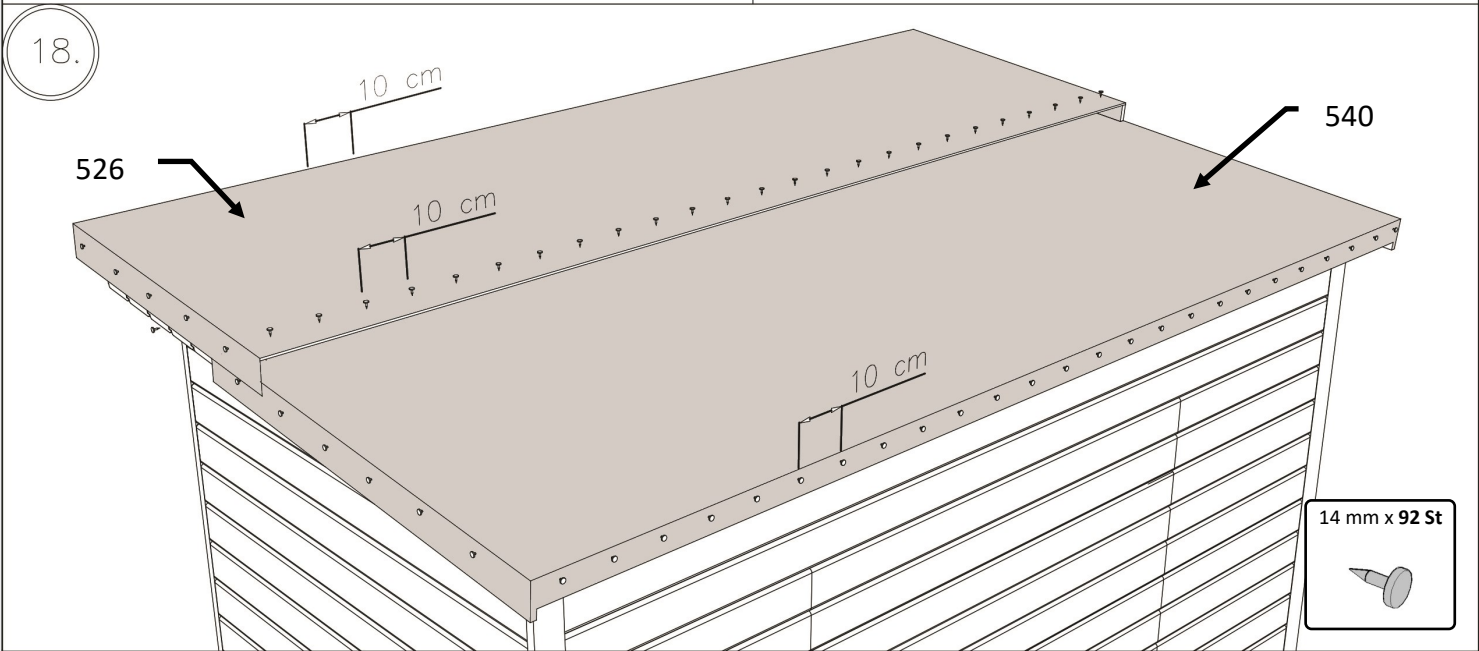
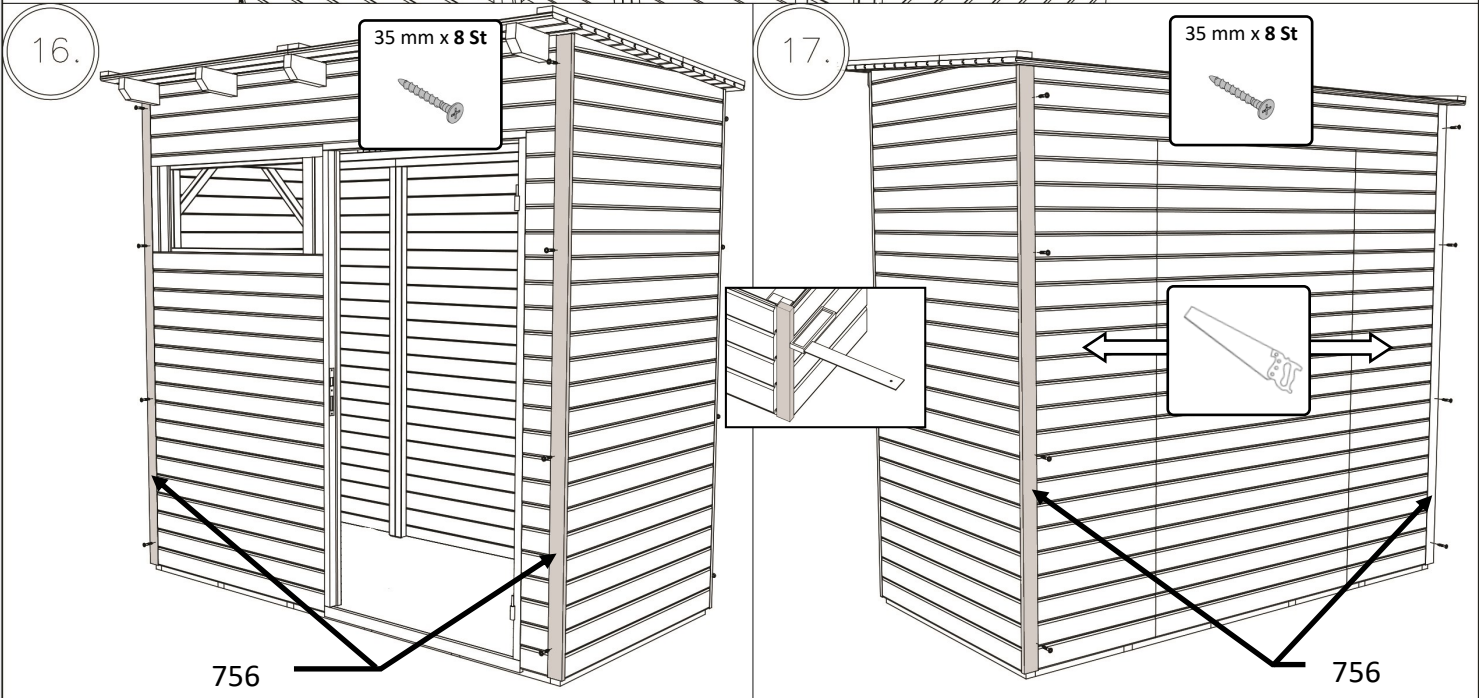
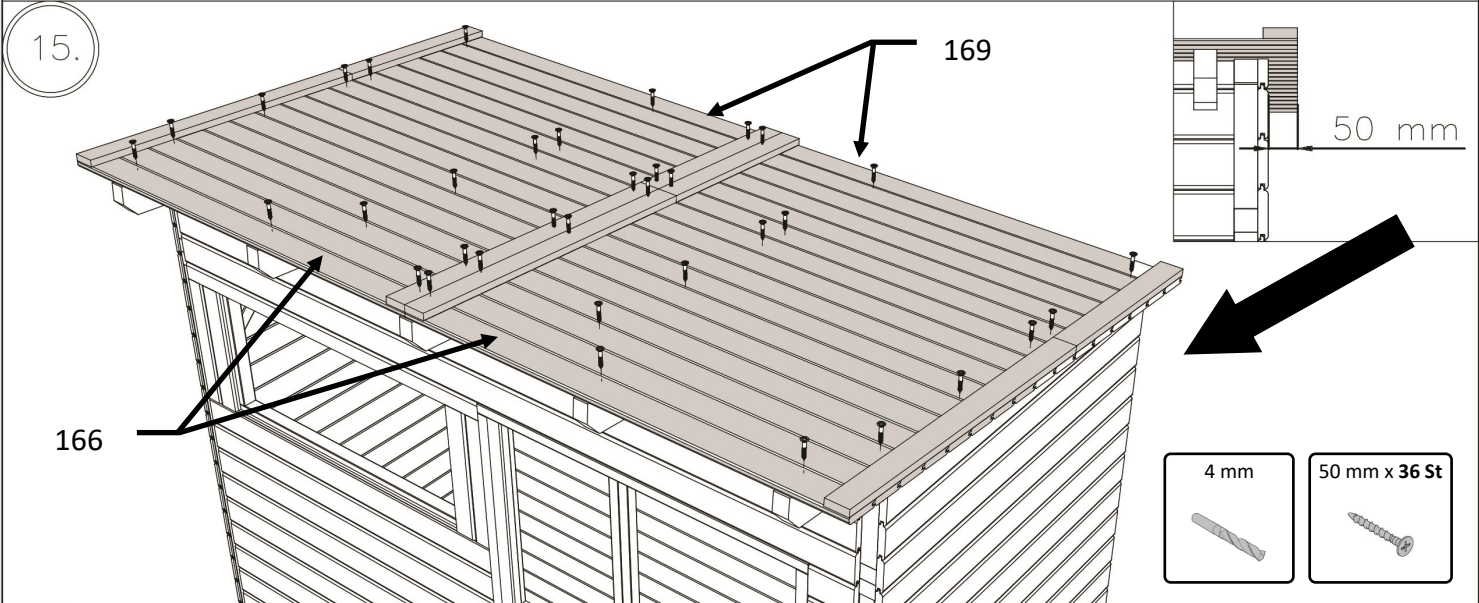

OTPE1(NF/GR)

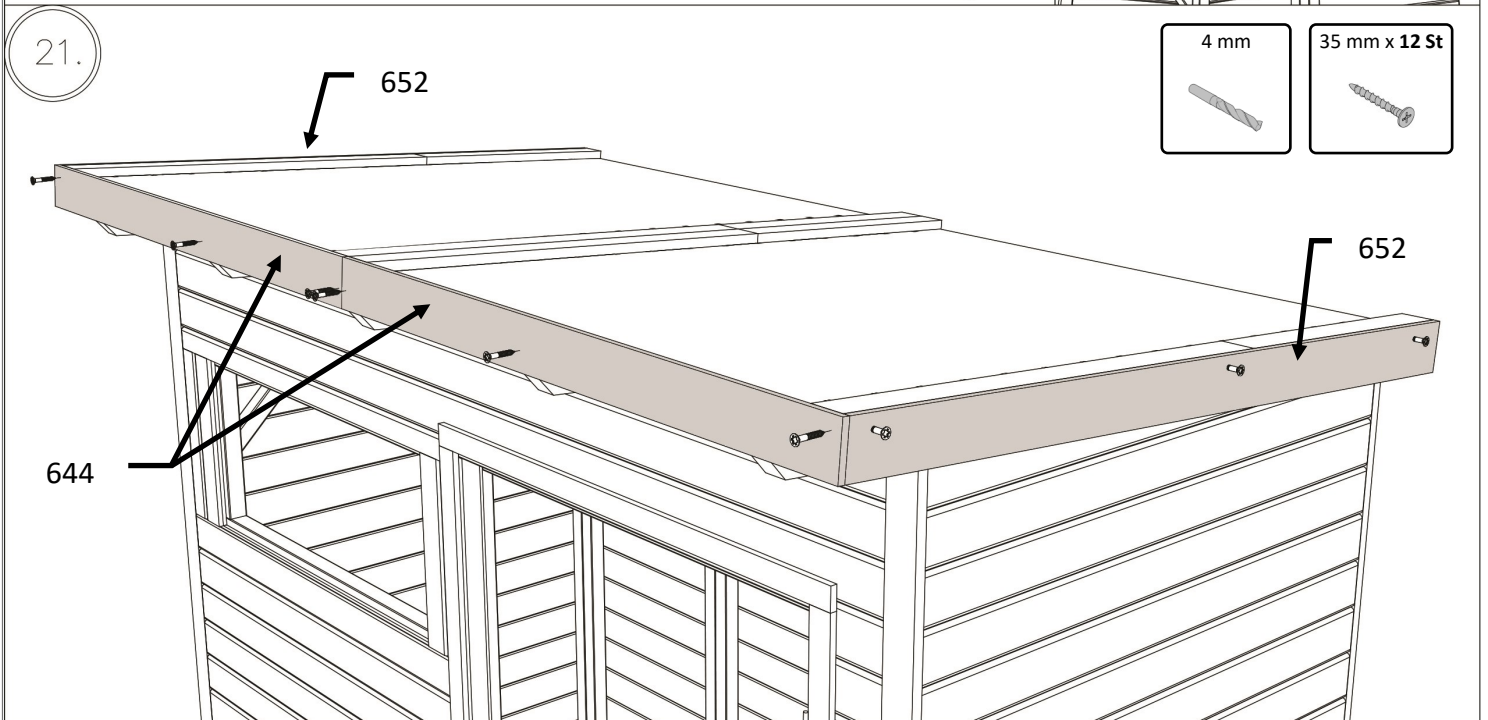
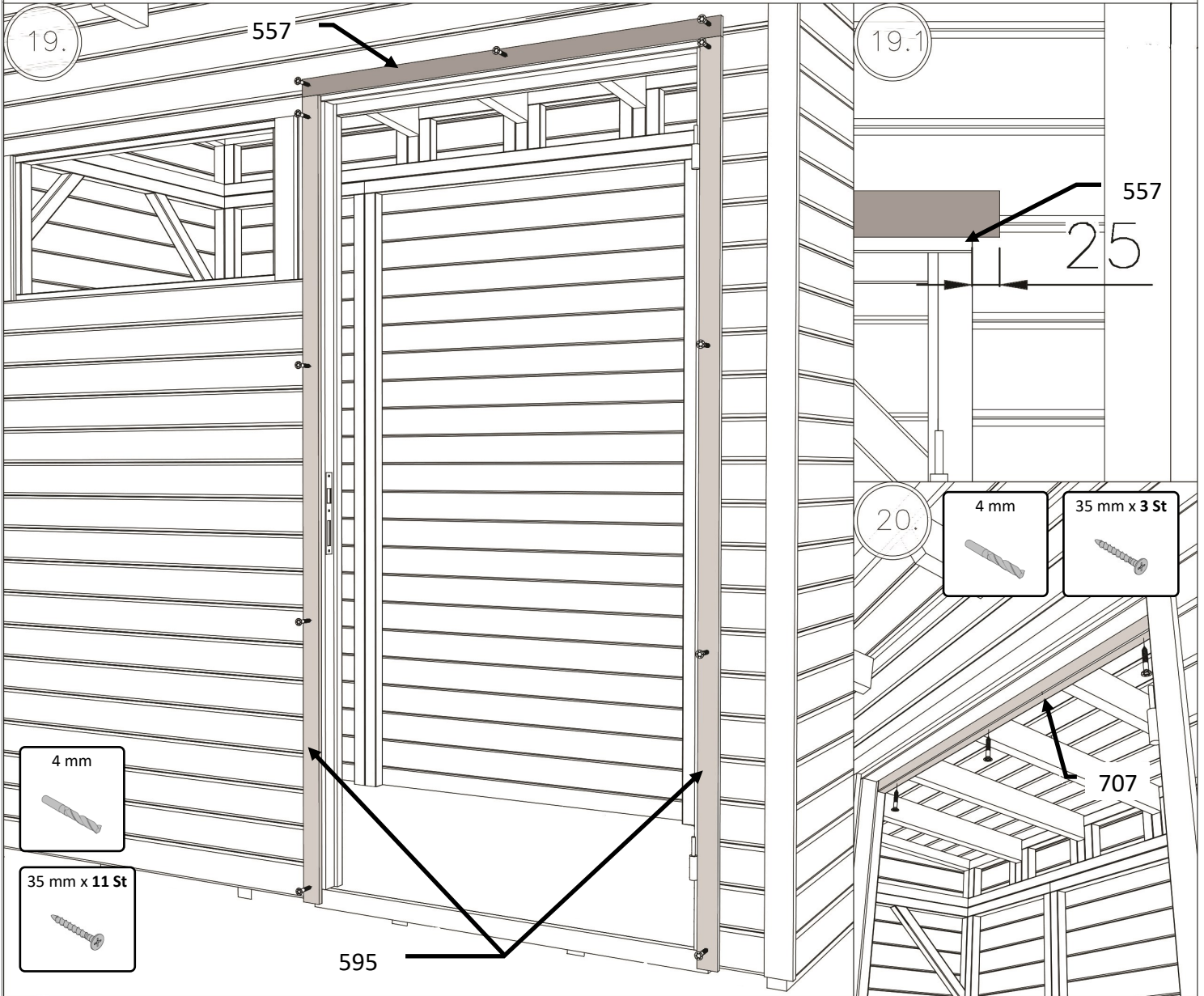

OTPE1(NF/GR)

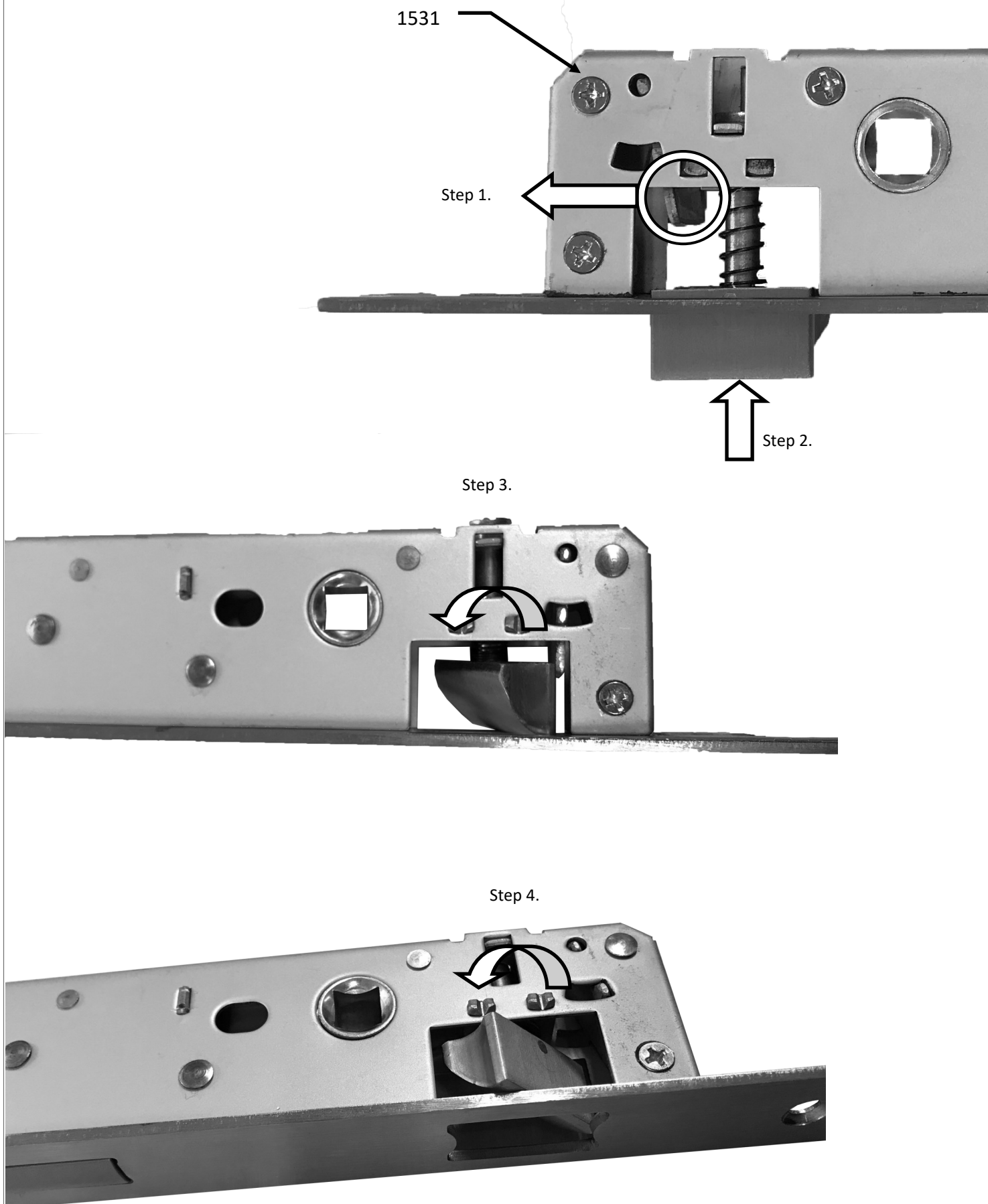

OTPE1(NF/GR)

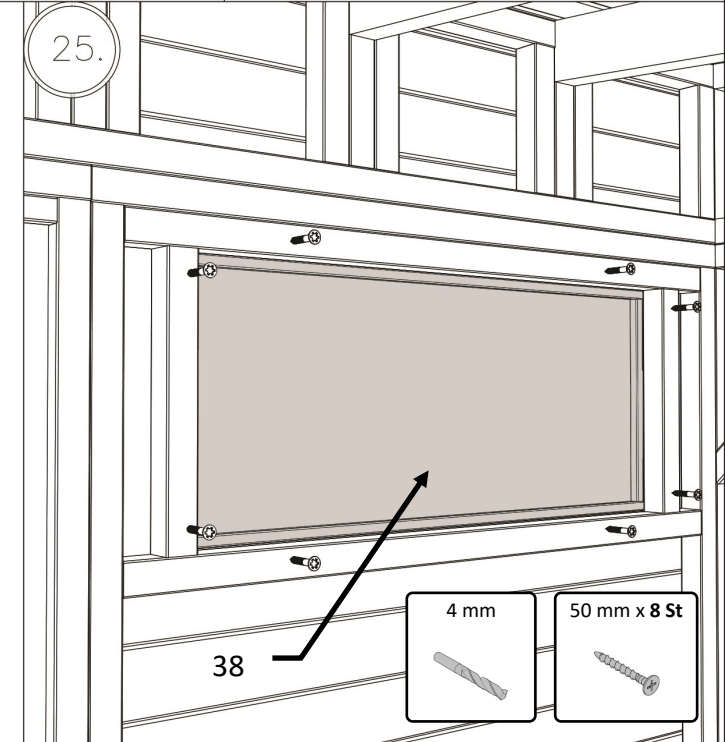
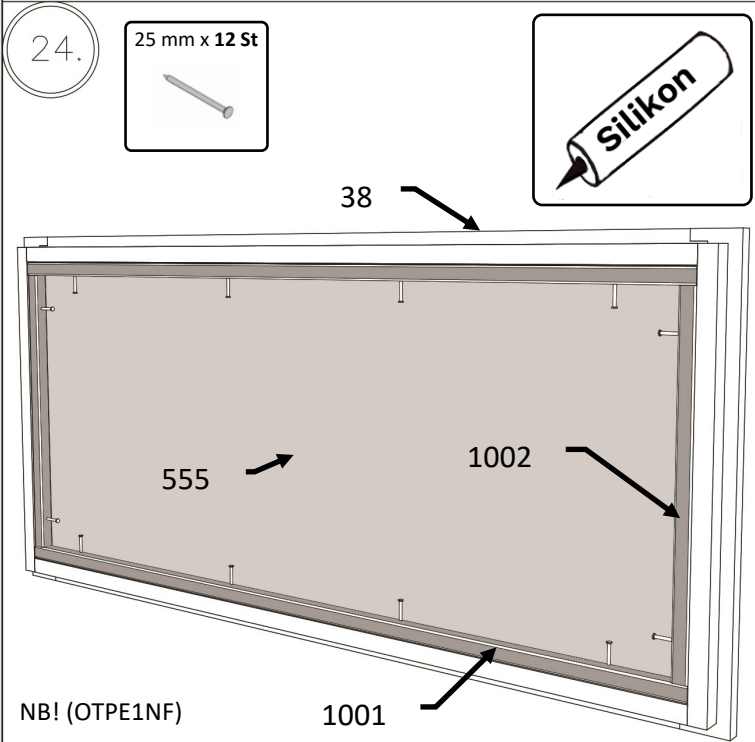
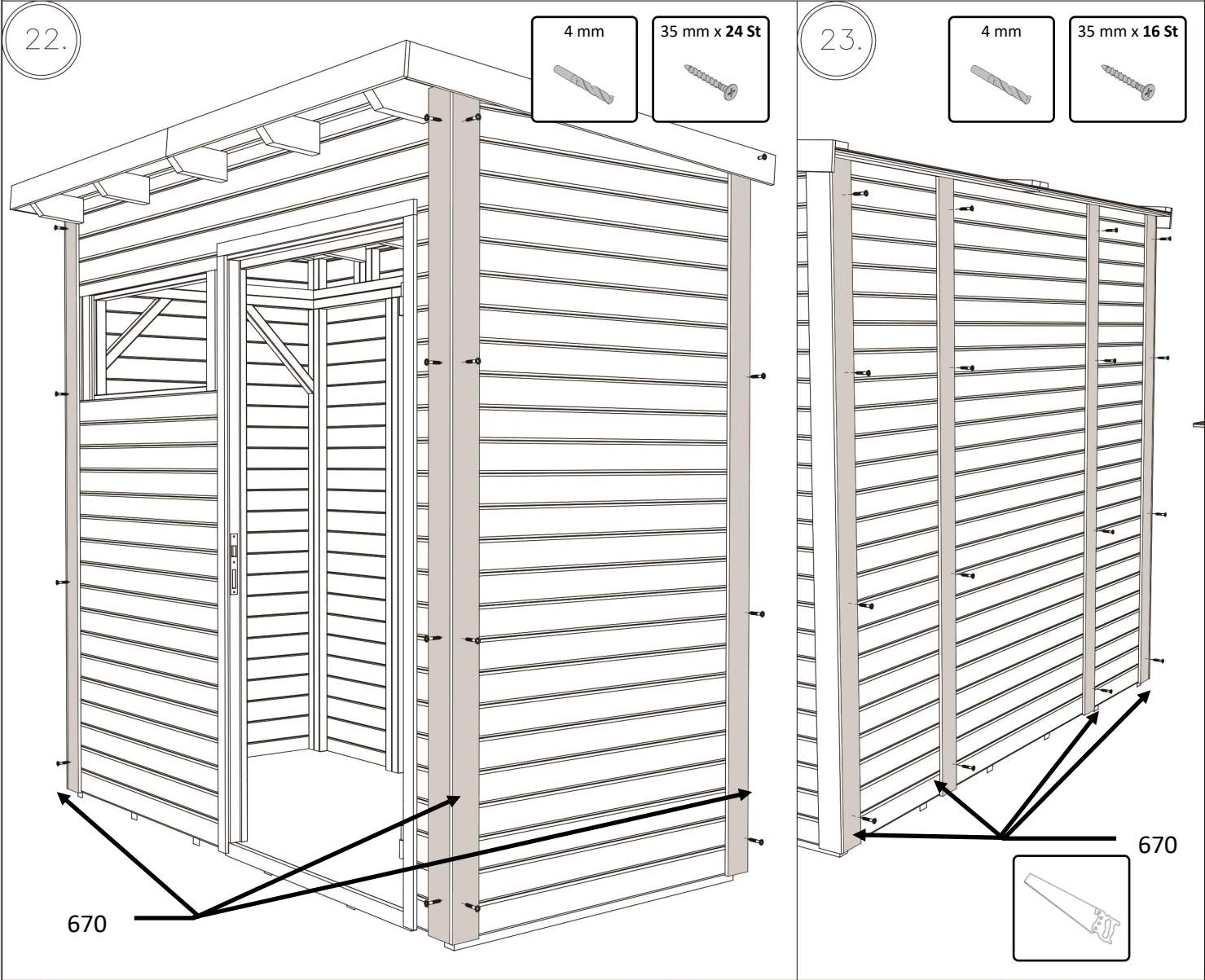

NB! OTPE1GR!!!!

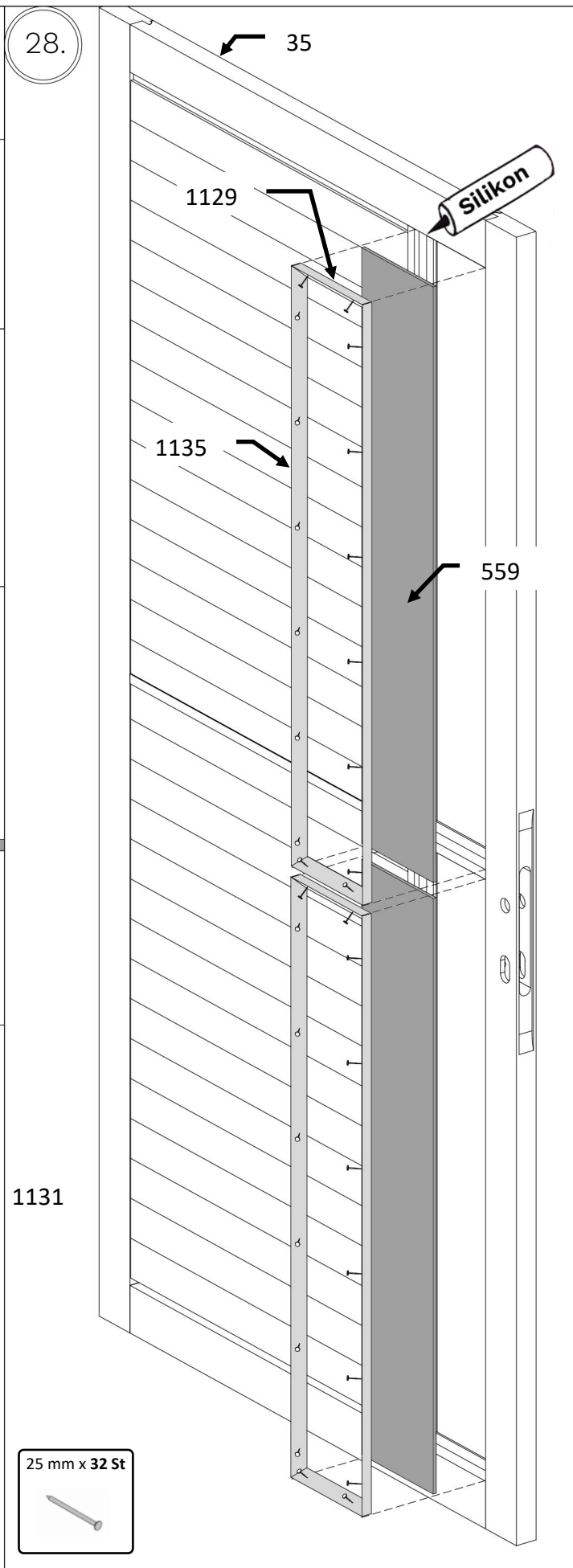
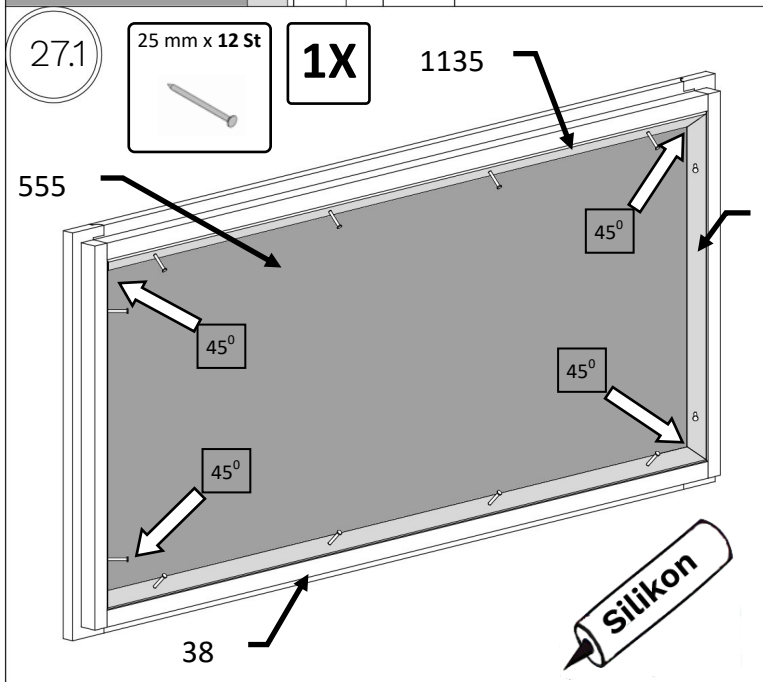
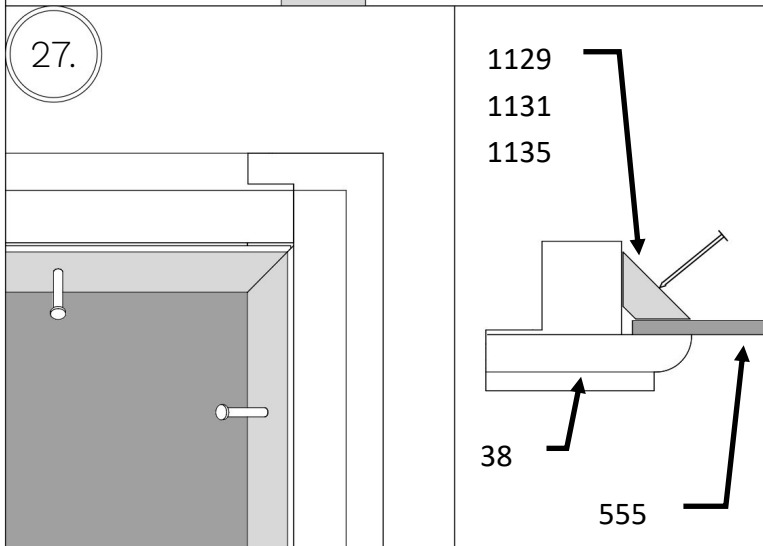
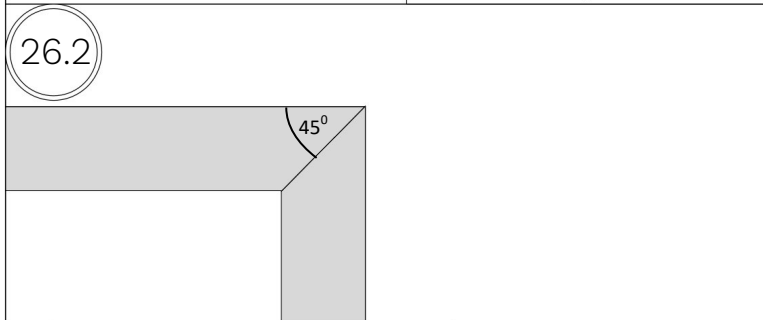
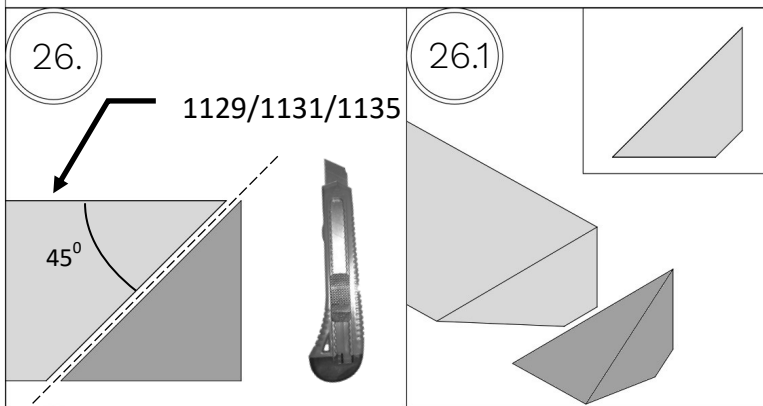

OTPE1(NF/GR)

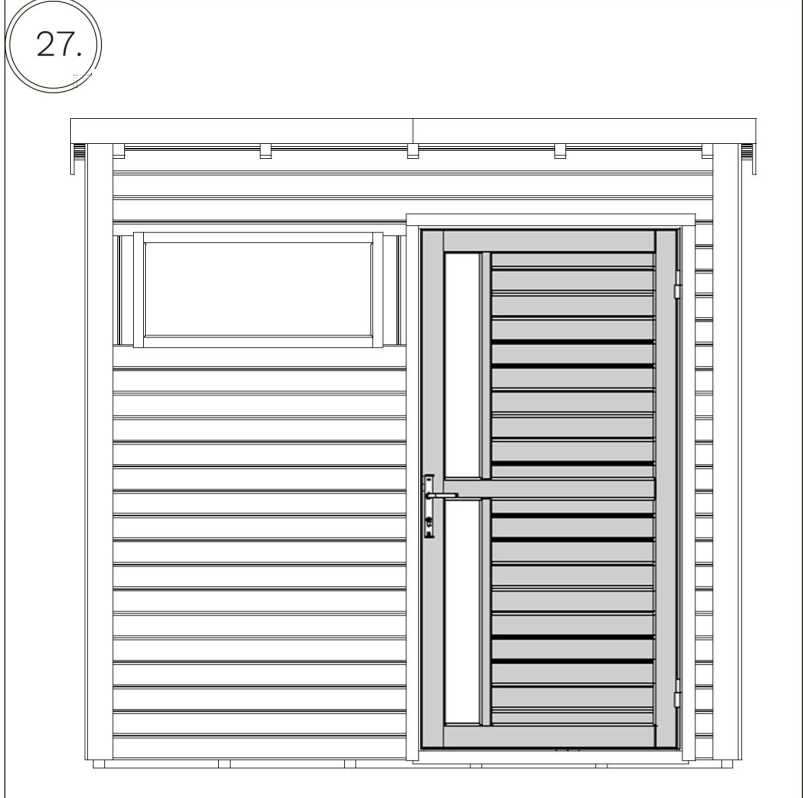
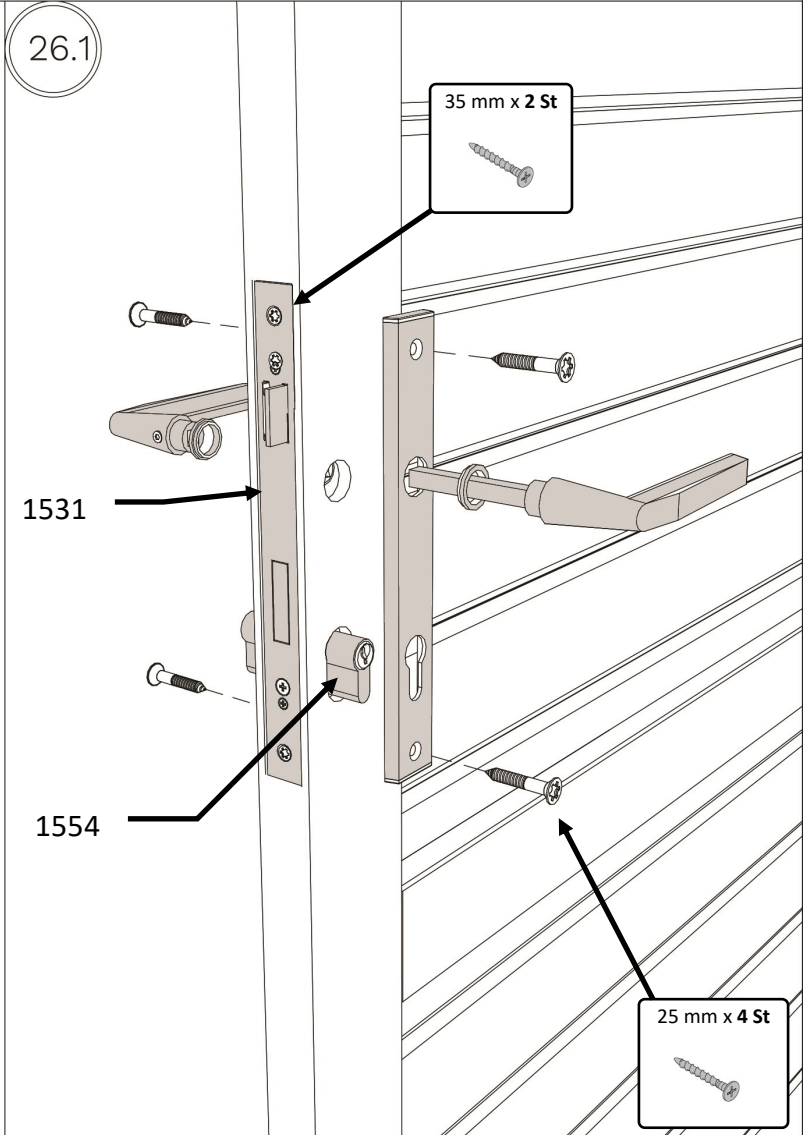
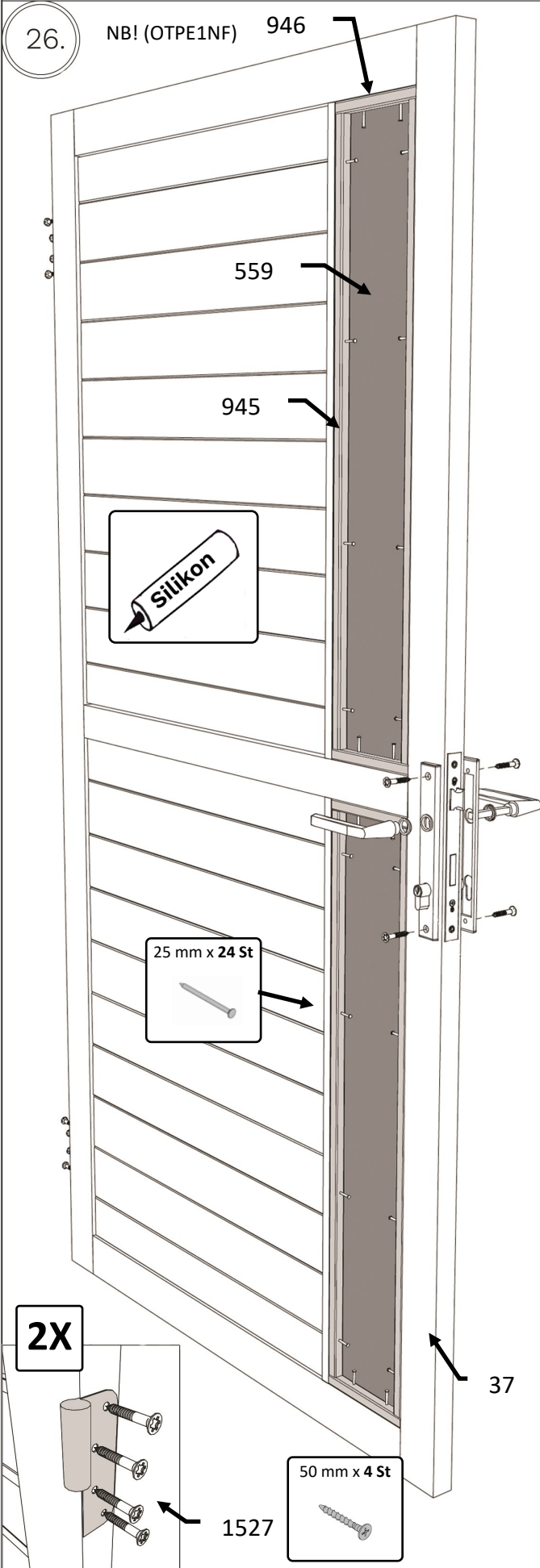

OTPE1(NF/GR)

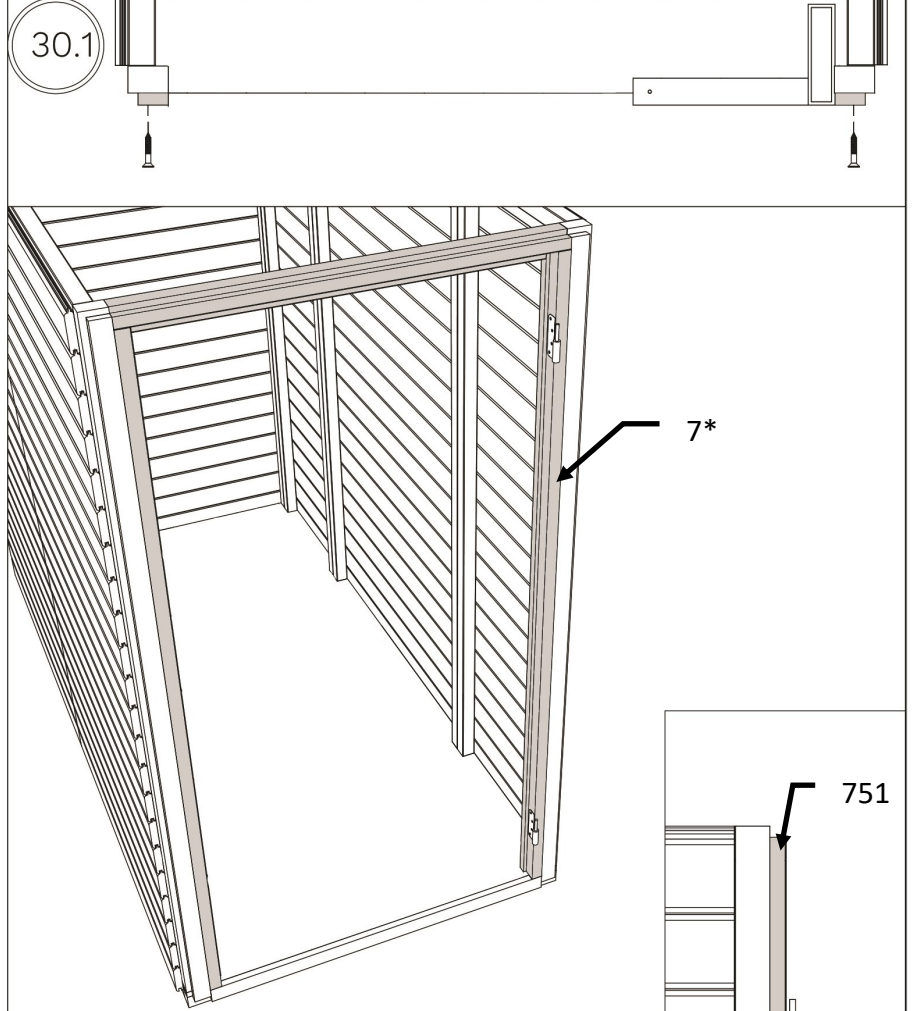
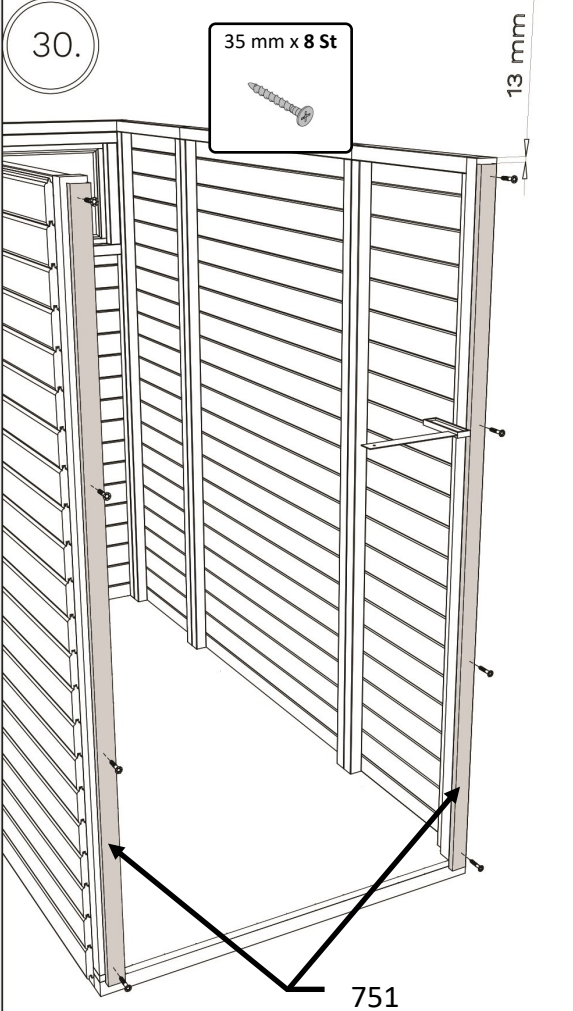
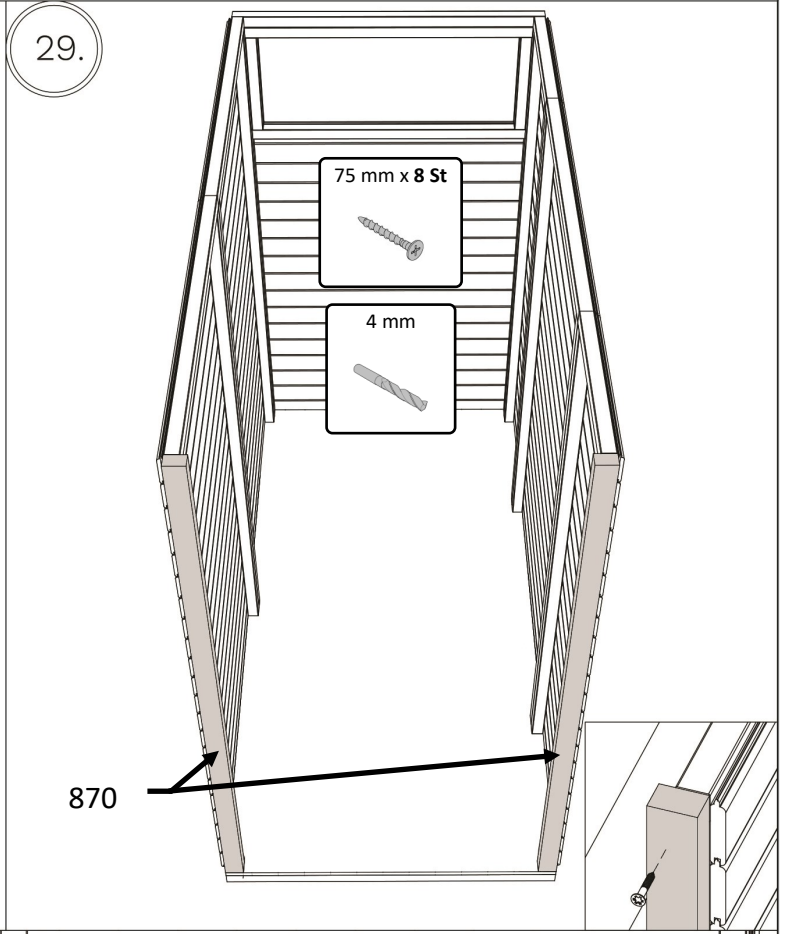

OTPE1(NF/GR)

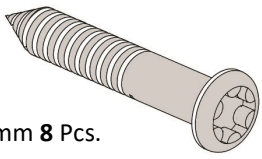

Version 1.

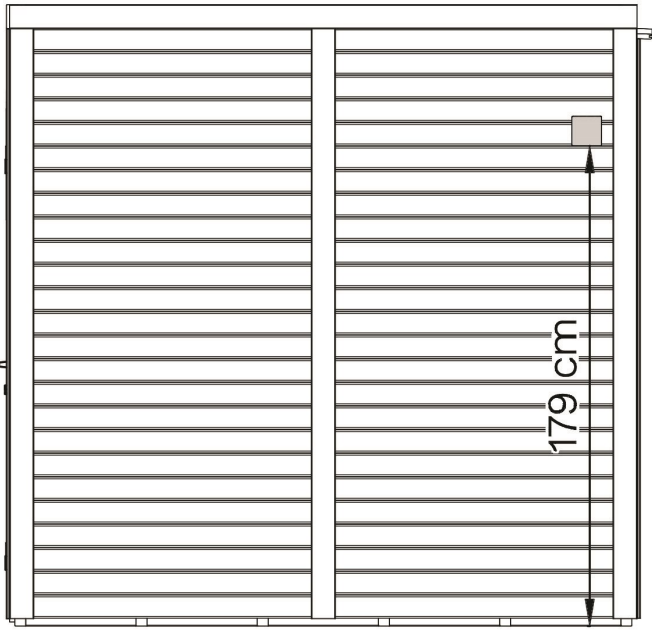
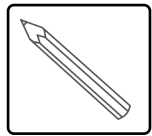
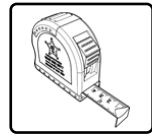
1. 
Ø3 x 19 mm 8 Pcs.
1557 2 Pcs.

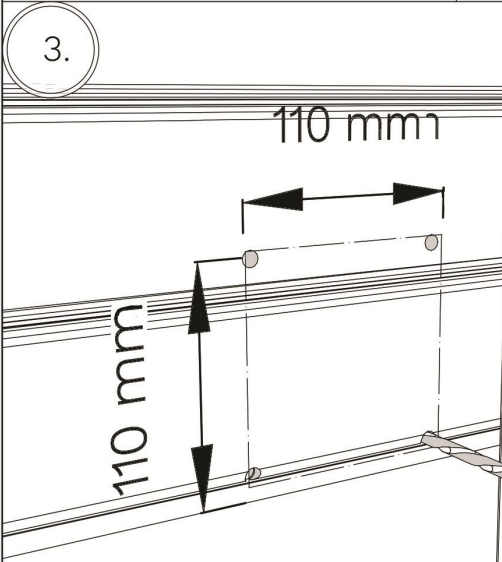
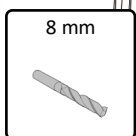
2. 

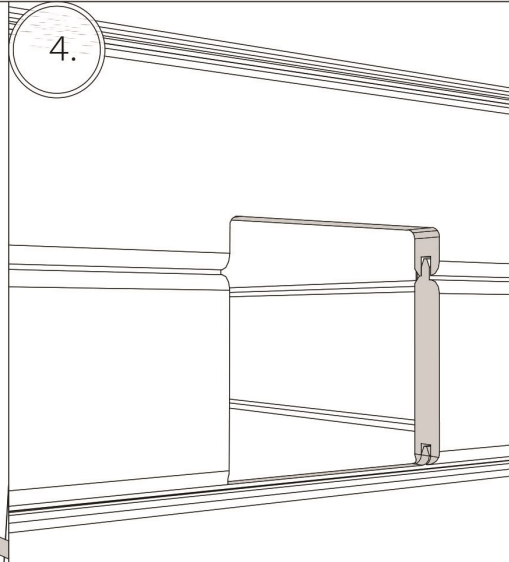
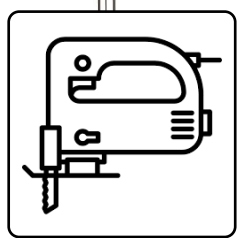

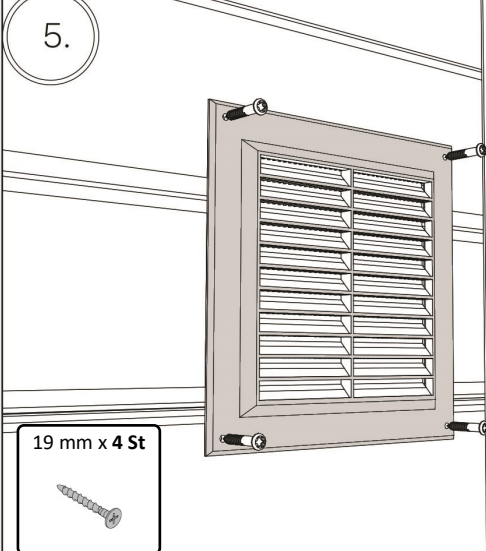
3. 
110 mm
110 mm

8 mm

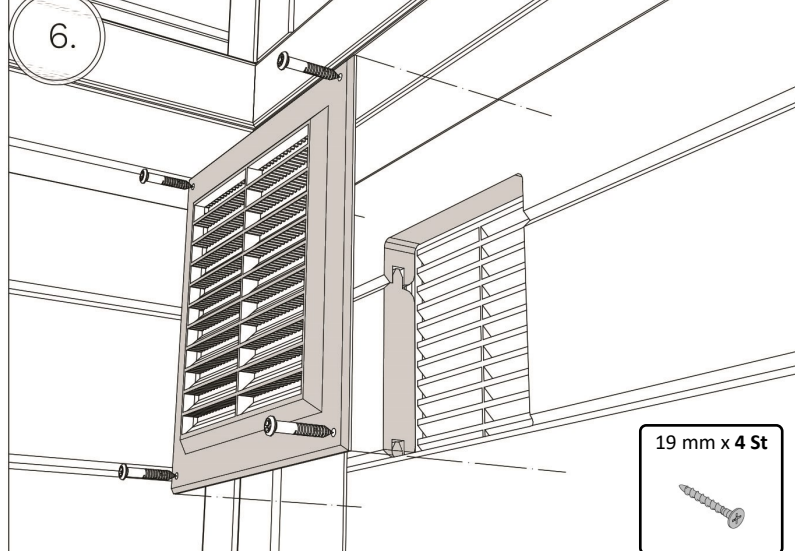
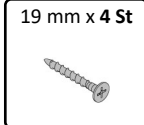
4. 

5. 

Silikon

19 mm x 4 St

6. 

19 mm x 4 St

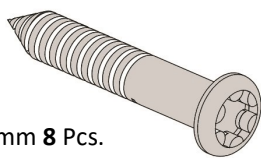
OTPE1(NF/GR)

Version 2.

1.



Ø3 x 19 mm 8 Pcs.

1557 2 Pcs.

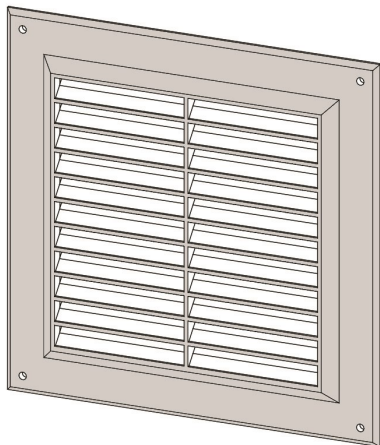

2.

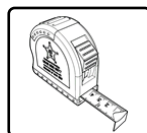
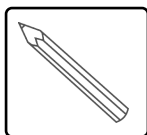
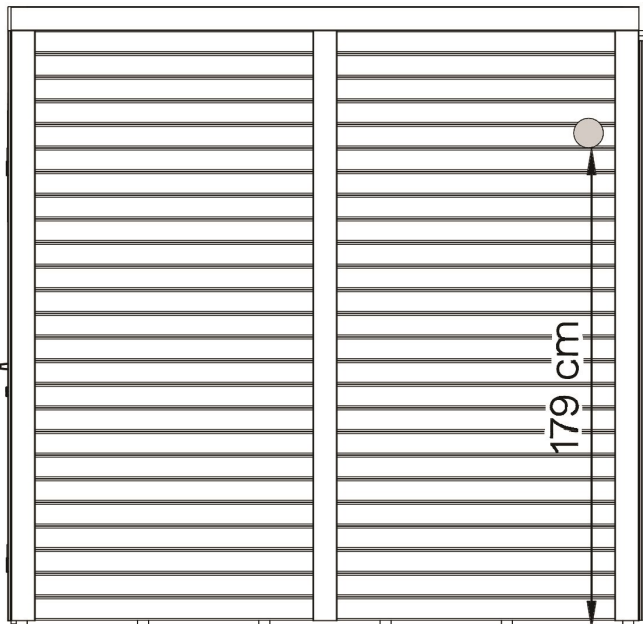

3.

8 mm



110 mm

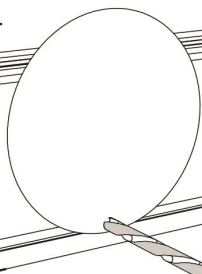

4.

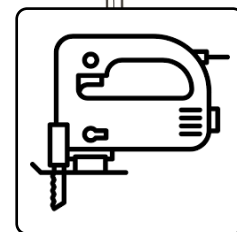

5.

Silikon



6.

19 mm x 4 St



19 mm x 4 St

